

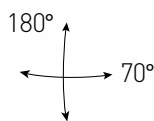

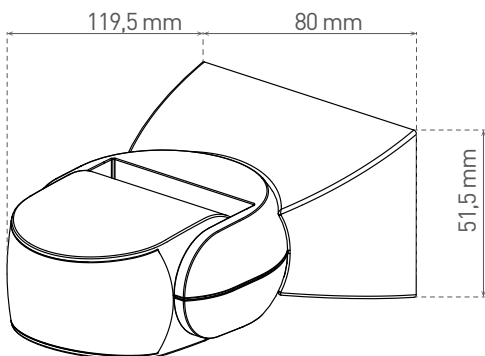













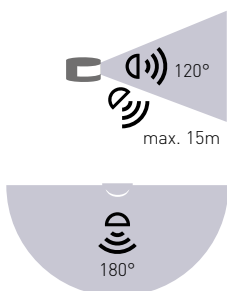

SENSOR HF 96



- POHYBOVÉ ČIDLO S HF
- mikrovlnné pohybové ovládání svítidel
- prachotěsné a voděodolné
- možnost regulace:
 - čas (TIME)
 - rozsah detekce pohybu (SENS)
 - nastavení (noc/den) (LUX)
- spínací prvek - RELÉ
- maximální zatížení 500W (PF≈1)
- spolupracuje s LED svídky

-  220-240V-50/60Hz
-  max. 1,75A 500VA-
- 
- IP 65**
- 
- 
-  -20+50°C
-  164
-  1/50
- CE**
-  RoHS



								
SENSOR HF 96	GXHF015	8592660120126	bílá	180	max. 15m	10s - 12min	5-15m	3-2000