

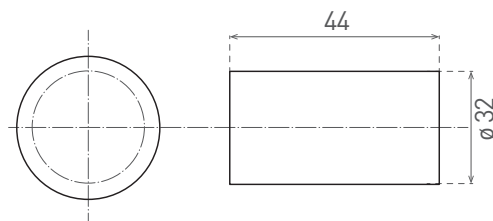

LH-E14

- KERAMICKÁ OBJÍMKA
- keramické tělo
- výborná tepelná odolnost



LH-E14	GXOS049	8592660103358	48	1/40/400

LH-E27

- KERAMICKÁ OBJÍMKA
- keramické tělo
- výborná tepelná odolnost

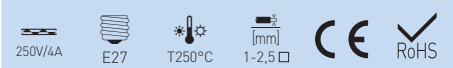
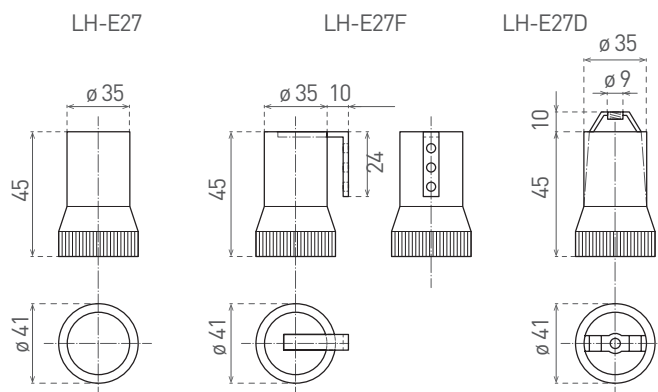

LH-E27	GXOS046	8592660103327	74	1/10/200
LH-E27F	GXOS047	8592660103334	76	1/10/200
LH-E27D	GXOS048	8592660103341	76	1/10/200