















Stropní bodové svítidlo



IP
44/20

 12 AC; 12 DC	 MR-16	 Gx5,3		 IP 44/20	
 Ø60-62		 0,12	 0,75	 0,5m	 
					



MARIN CT-S80-C



				
MARIN CT-S80-C	04703	max 35	chrome	chybějící
MARIN CT-S80-SN	04704	max 35	matný nikl	chybějící
MARIN CT-S80-AB	04710	max 35	matná mosaz	chybějící
MARIN CT-S80-W	32500	max 35	bílá	chybějící
MARIN CT-S80-B	32501	max 35	černá matná	chybějící

Kanlux MARIN je malé těsné stropní svítidlo, které můžeme použít v místech s vysokou vlhkostí. Můžeme je snadno umístit do koupelny nad zrcadlem, do kuchyně nebo do prádelny.

- Materiál korpusu: ocel

MARIN

Stropní bodové svítidlo



MARIN CT-S80-SN



MARIN CT-S80-AB



MARIN CT-S80-W



MARIN CT-S80-B

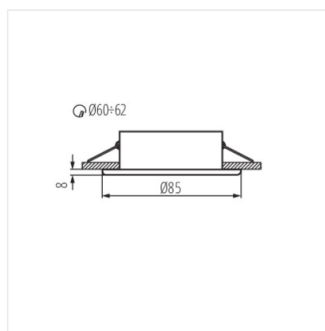

MARIN CT